

# 931-HSL(-HT)

Pin strip  
 Plug-in area  $\varnothing$  1,15 mm

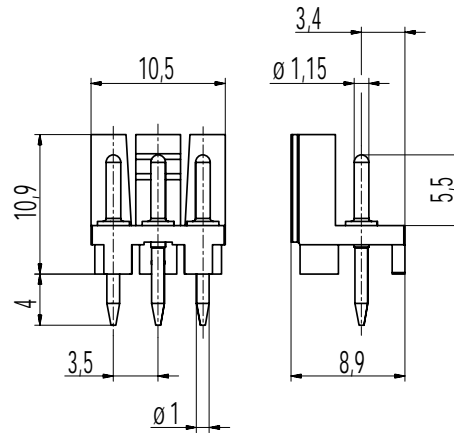

## GENERAL INFORMATION

Pitch	3,5 mm
No. of poles	3

## TECHNICAL DATA

Overvoltage Category	III	III	II
Pollution Severity Level	3	2	2
Rated Voltage	160 V	160 V	320 V
Rated Impulse Voltage	2,5 kV	2,5 kV	2,5 kV
Rated Insulation Voltage	130 V acc. to EN 60998-1		
Rated Current	6 A		
Hole in PCB	$\varnothing$ 1,3 mm		

## APPROVALS

	Current [A]	Voltage [V]	Group	AWG	[Nm]
	6	300	B		
	6	300	B		

## MATERIAL

Moulding	PA HT, black, V-0
Comparative Tracking Index	CTI $\geq$ 600
Insulating Group	I
Temperature Range	-40°C up to 120°C
Solder pin	$\varnothing$ 1,0 mm; $\varnothing$ 1,15 mm (plug-in area); tin plated brass

## CONFIGURATIONS

Poles	Part number	Article number	Part number	Article number	Length (L)	Packaging	PU
3	931-HSL/03		931-HSL-HT/03	20.893.773	10,5 mm	250	

